

## USB医疗脚踏开关

USB脚踏开关是计算机输入的一种比较舒服和方便的方式。用户可以根据需要，预先通过软件指定脚踏开关对应键盘的某个键或某几个键的输入功能。

### 特性:

- 标准产品提供: 单脚踏, 双脚踏和3脚踏  
(如果需要超过3脚踏, 可以使用两个独立的脚踏开关)
- 通过附带的软件设定脚踏开关对应键盘功能
- 使用时只需要有USB接口
- 兼容 Windows 操作系统 Windows XP/Vista/7/10
- 防水医疗级脚踏开关
- 符合IEC60601-1和YY1057标准
- 多种外壳颜色可选

### 技术指标

操作频率	60 次/分钟
绝缘电阻	>100MΩ@500V DC
接点电阻	<25mΩ (初值)
寿命	1 x 10 <sup>6</sup> 次
使用温度范围	-20~+85°C (-4~185°F)
防护等级	IPX8

### 选型指南:

FS-81 - SP	-	Twin	-	M	-	USB
		脚踏板数		踏板材料		标准线为3米
		— 空白: 单脚踏		— 空白: 纤维增强塑料		
		— Twin: 2 脚踏		— M: 锌合金		
		— 3-pedal: 3 脚踏				

### 安装尺寸:

\*注: FS-8系列USB脚踏仅作为代表, 所有的SUNS医疗脚踏都能提供USB款

#### FS-81-SP-USB

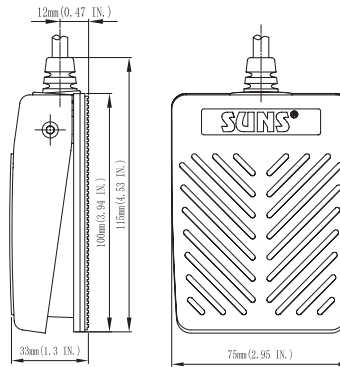

#### FS-81-SP-(Twin)-USB

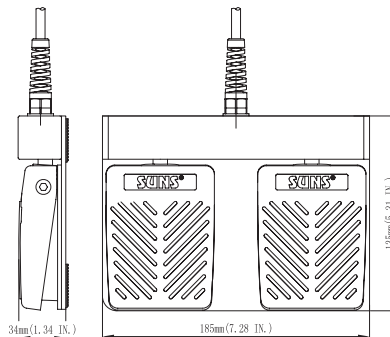

#### FS-81-(3-Pedal)-USB

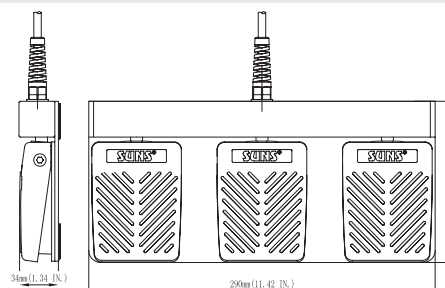

## USB医疗脚踏开关

### 选型指南:

FS-81	-	SP	-	W	-	M	-	USB	
脚踏板数								踏板材料 标准线为3米	
81: 1 脚踏								空白: 纤维增强塑料	
82: 2 脚踏								M: 锌合金	
83: 3 脚踏									

### 安装尺寸:

#### FS-81-SP-W-USB

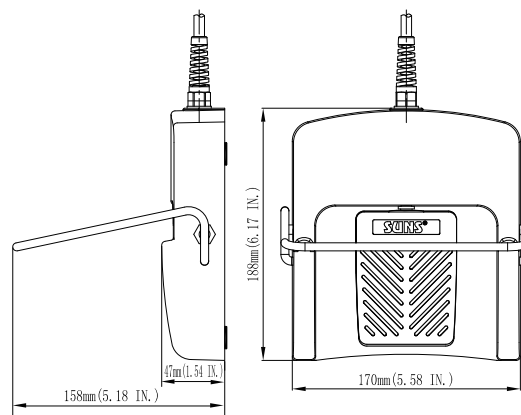
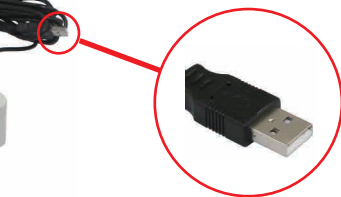

#### FS-82-SP-W-USB

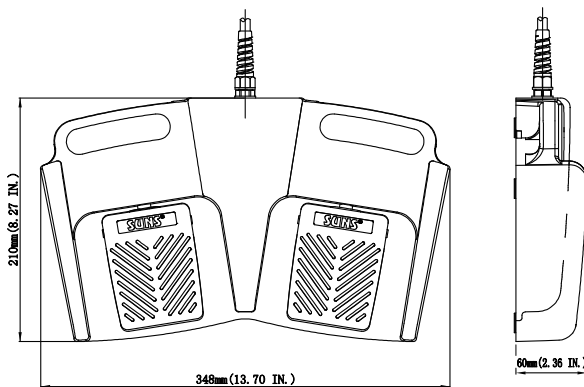
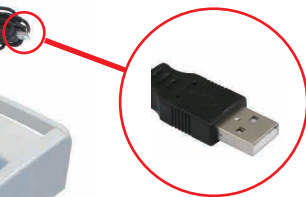

#### FS-83-SP-W-USB

